

Technical drawings are subject to change without notice.
All millimeter dimensions are exact and supersede inch conversions.

Copyright MWE NA Inc., all rights reserved. Reproduction or other use of these designs without written consent from MWE NA Inc. is prohibited.
All ladder systems require reinforced walls, cabinets or shelving.

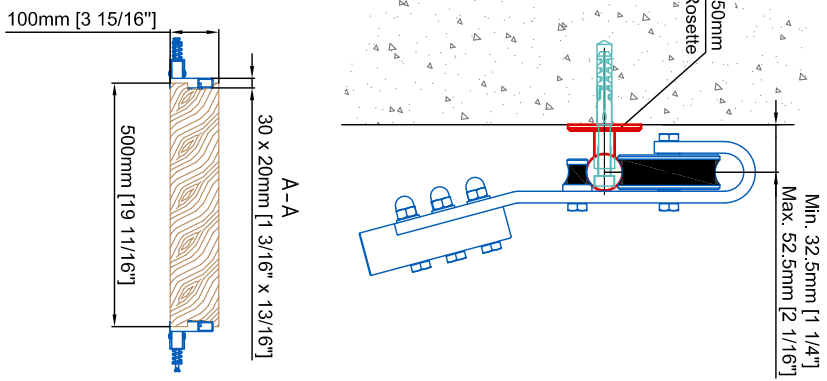
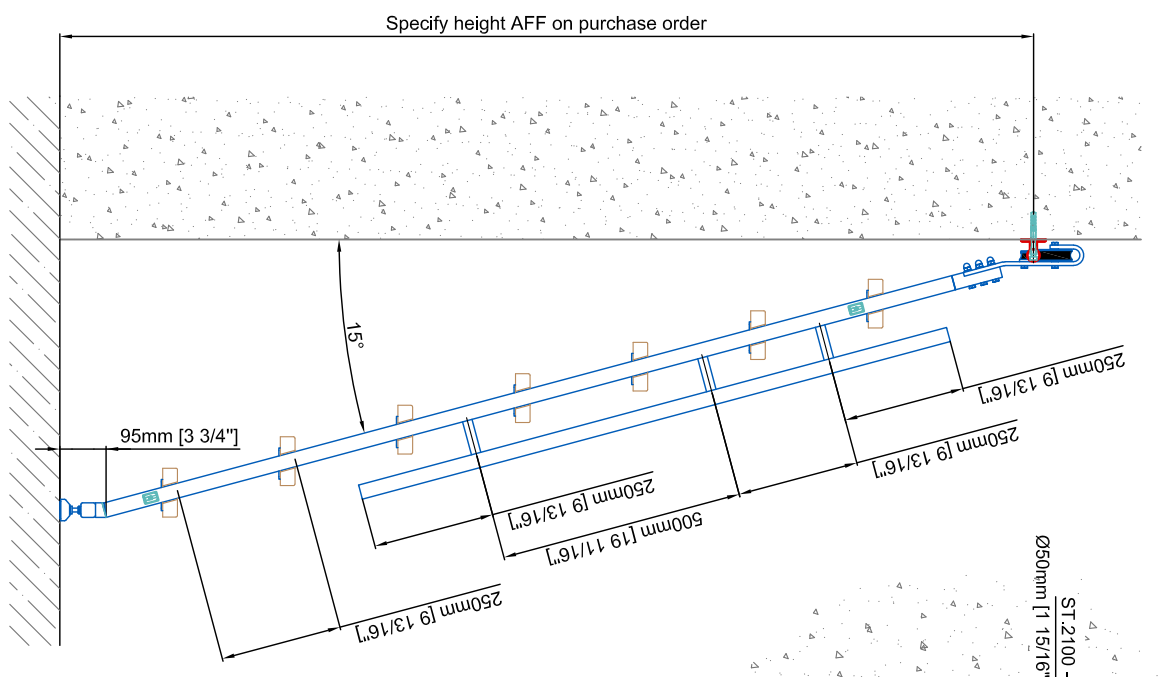
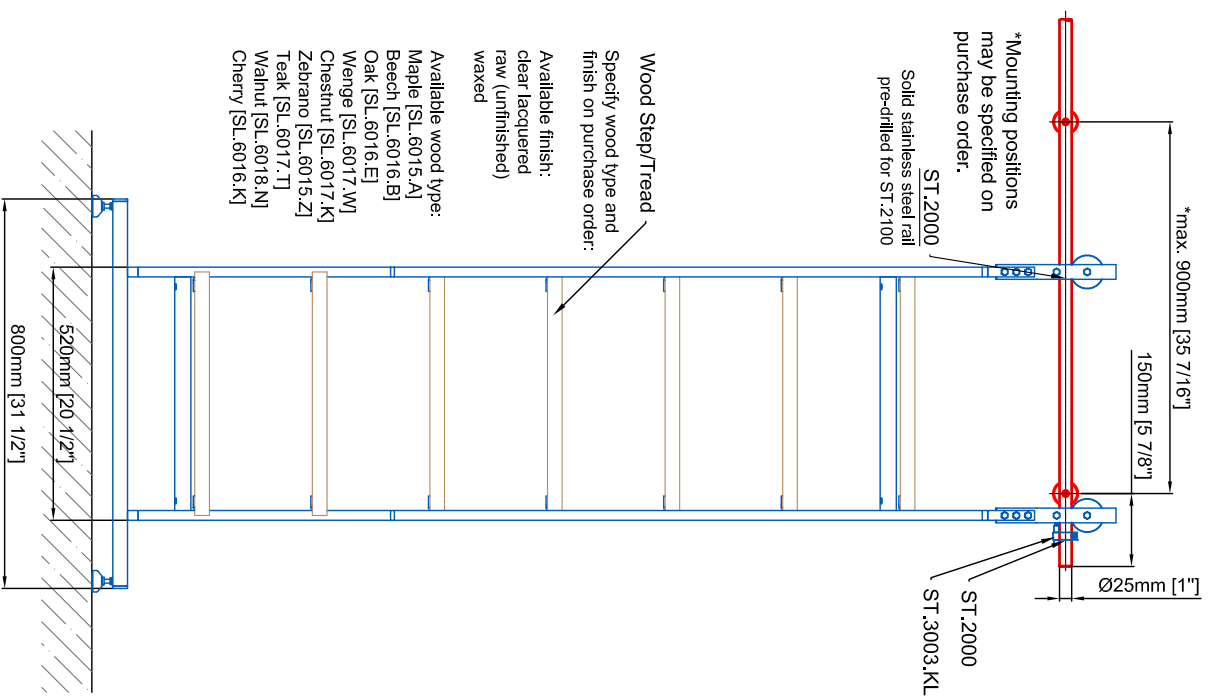

Industrial Ladder SL.6022.A

Date Prepared: Sept. 2019 Prepared By: CDA



NORTH AMERICA

Tel.: 954-982-6595
Email: sales@mwe-na.com
www.mwe-na.com

Technical drawings are subject to change without notice.
 All millimeter dimensions are exact and supersede inch conversions.
Ladder height at or above 3000mm [118 1/8"]
 require safety side rails SL.6052.AK

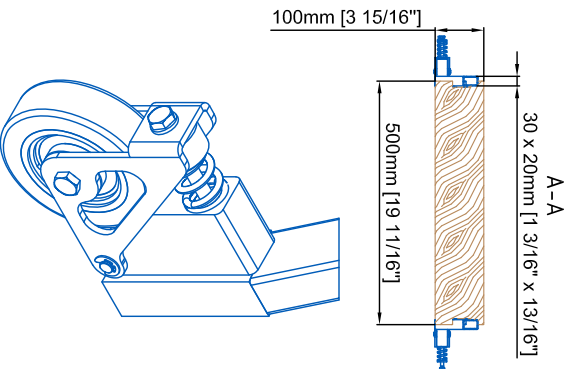
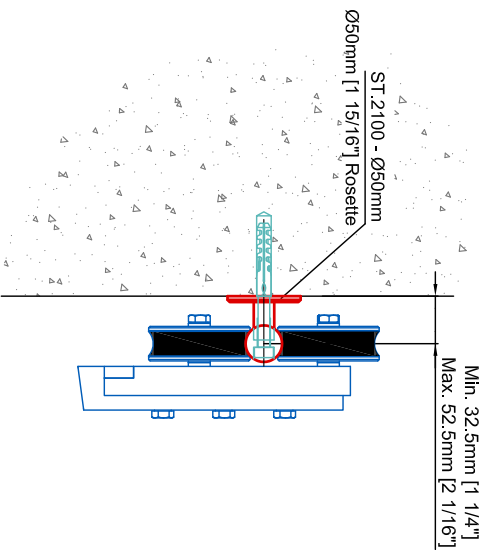
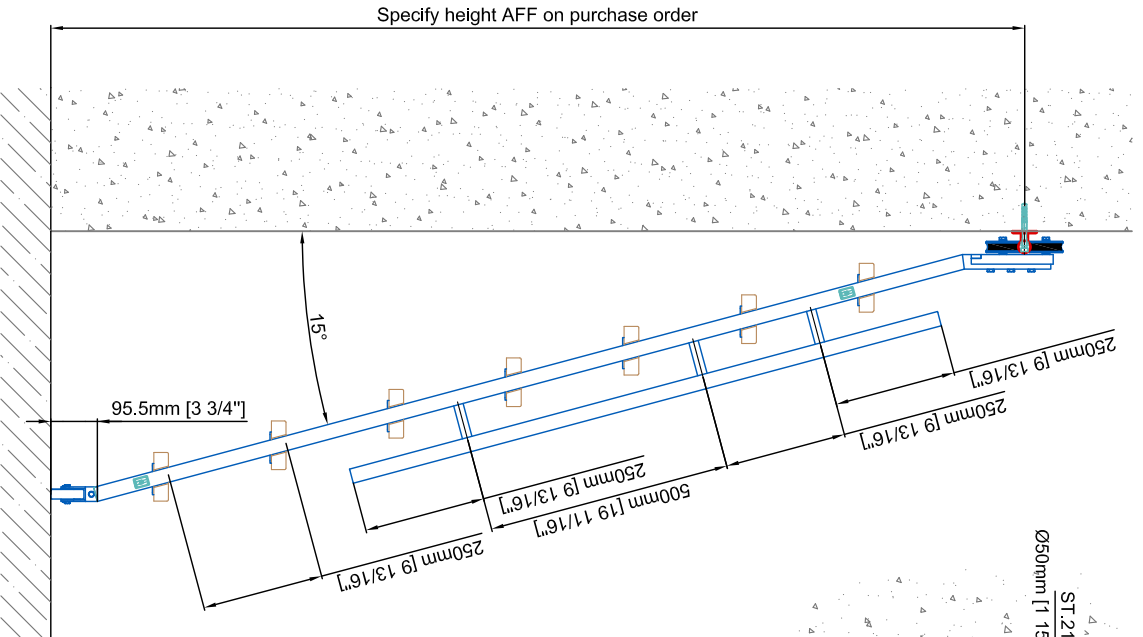
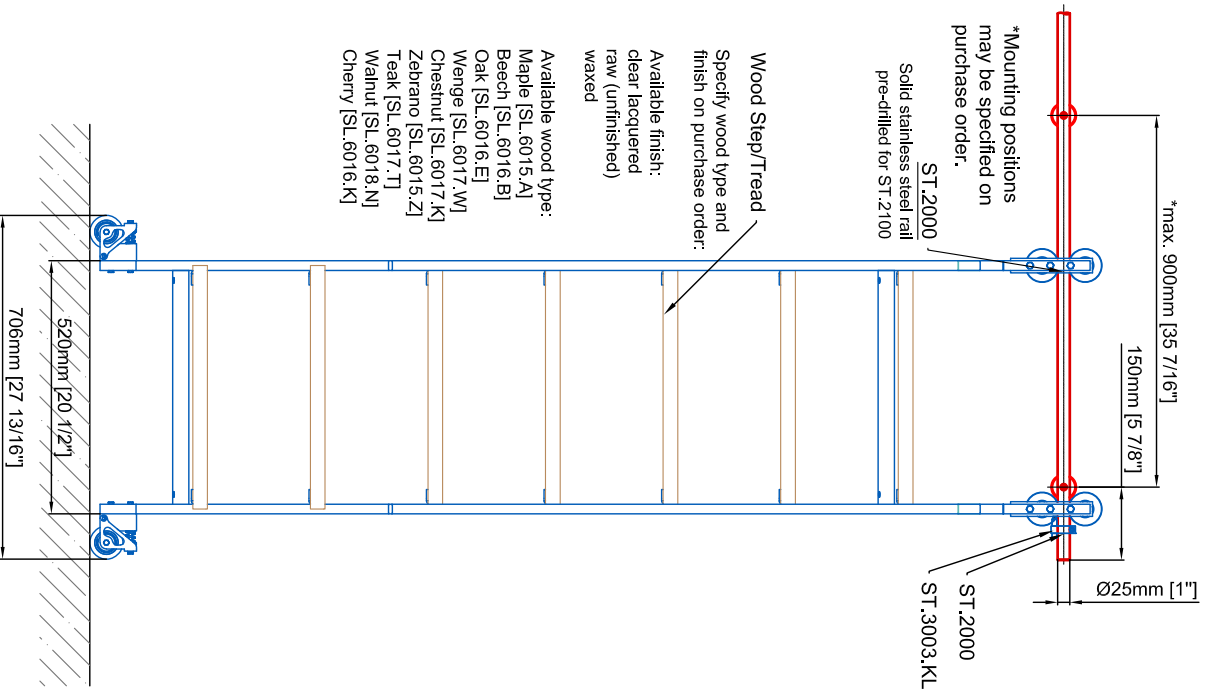

Copyright MWE NA Inc., all rights reserved. Reproduction or other use of these designs without written consent from MWE NA Inc. is prohibited.
 All ladder systems require reinforced walls, cabinets or shelving.

Industrial Ladder SL.6022.Q

Date Prepared: Sept. 2019

Prepared By: CDA



NORTH AMERICA

Tel.: 954-982-6595

Email: sales@mwe-na.com

www.mwe-na.com