

Technical drawings are subject to change without notice.
 All millimeter dimensions are exact and supersede inch conversions.

Copyright MWE NA Inc., all rights reserved. Reproduction or other use of these designs without written consent from MWE NA Inc. is prohibited.

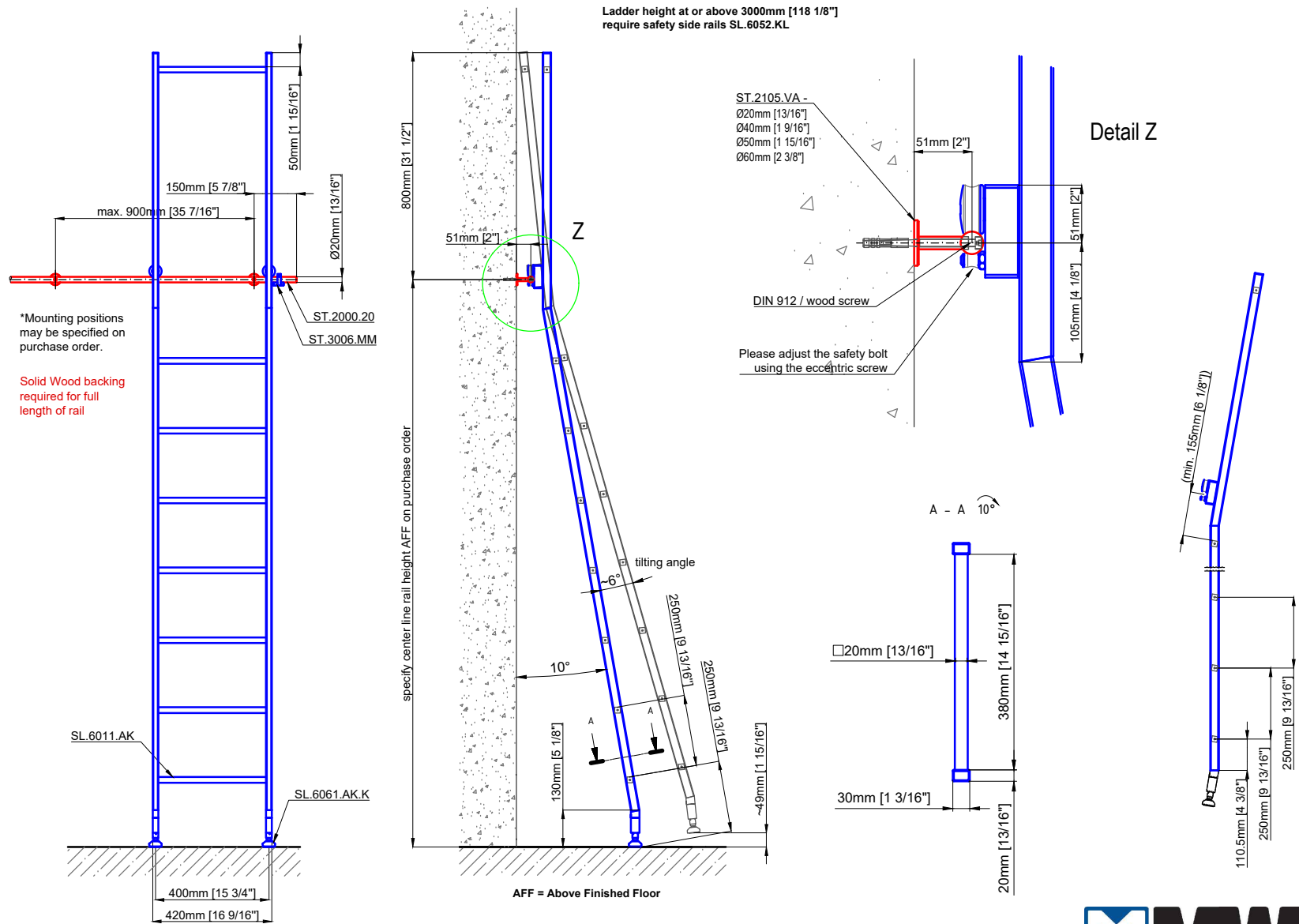

Tangens sliding ladder

SL.6006.AK

Date Prepared: April 2024

Prepared By: AB

MWE[®]
 Stainless Steel Manufacturer
 NORTH AMERICA
 Email: sales@mwe-na.com
www.mwe-na.com

Technical drawings are subject to change without notice.
 All millimeter dimensions are exact and supersede inch conversions.

Copyright MWE NA Inc., all rights reserved. Reproduction or other use of these designs without written consent from MWE NA Inc. is prohibited.

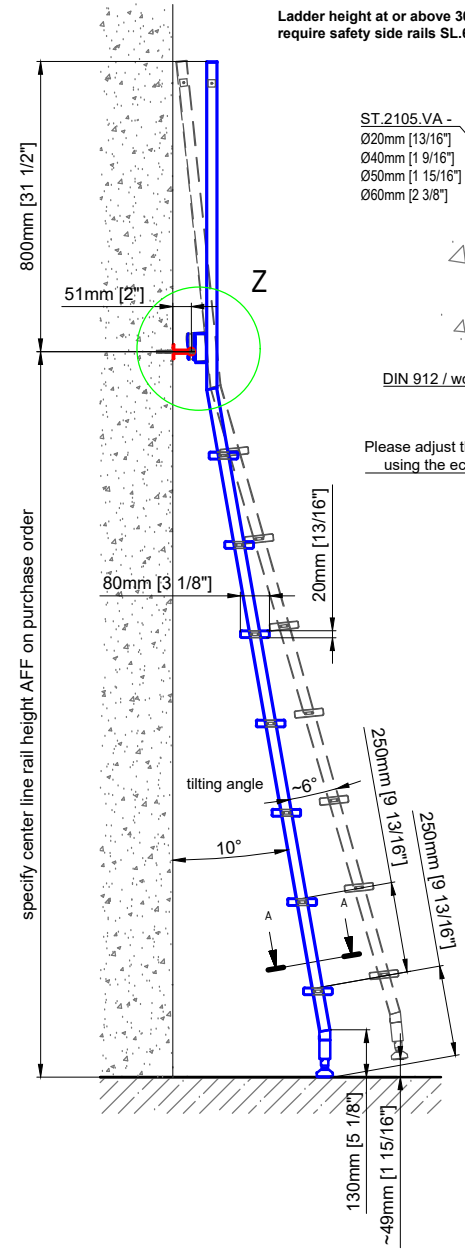
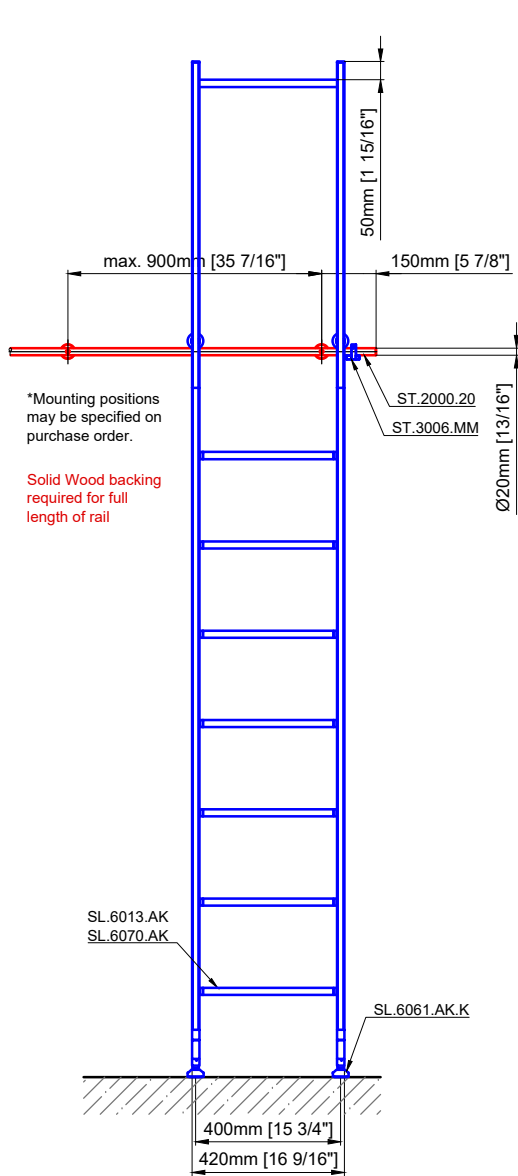

Ladder height at or above 3000mm [118 1/8"] require safety side rails SL.6052.KL

ST.2105.VA -
 Ø20mm [13/16"]
 Ø40mm [1 9/16"]
 Ø50mm [1 15/16"]
 Ø60mm [2 3/8"]

DIN 912 / wood screw

Please adjust the safety bolt using the eccentric screw

Detail Z

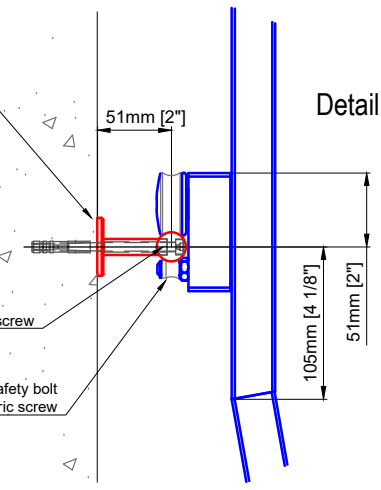

A - A 10°

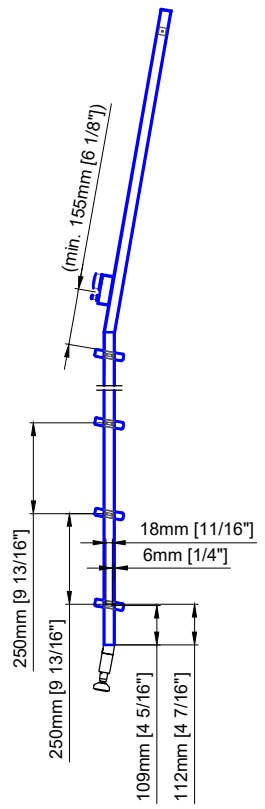
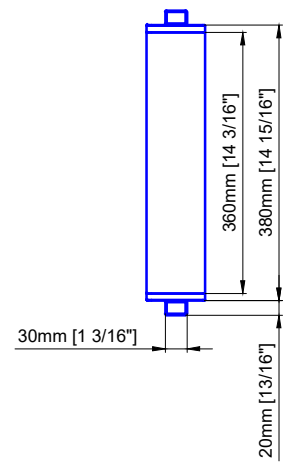

Tangens sliding ladder

SL.6003.AK.E

Date Prepared: May 2024 | Prepared By: AB

MWE[®]
 Stainless Steel Manufacturer
 NORTH AMERICA
 Email: sales@mwe-na.com
www.mwe-na.com

Technical drawings are subject to change without notice.
 All millimeter dimensions are exact and supersede inch conversions.

Copyright MWE NA Inc., all rights reserved. Reproduction or other use of these designs without written consent from MWE NA Inc. is prohibited.

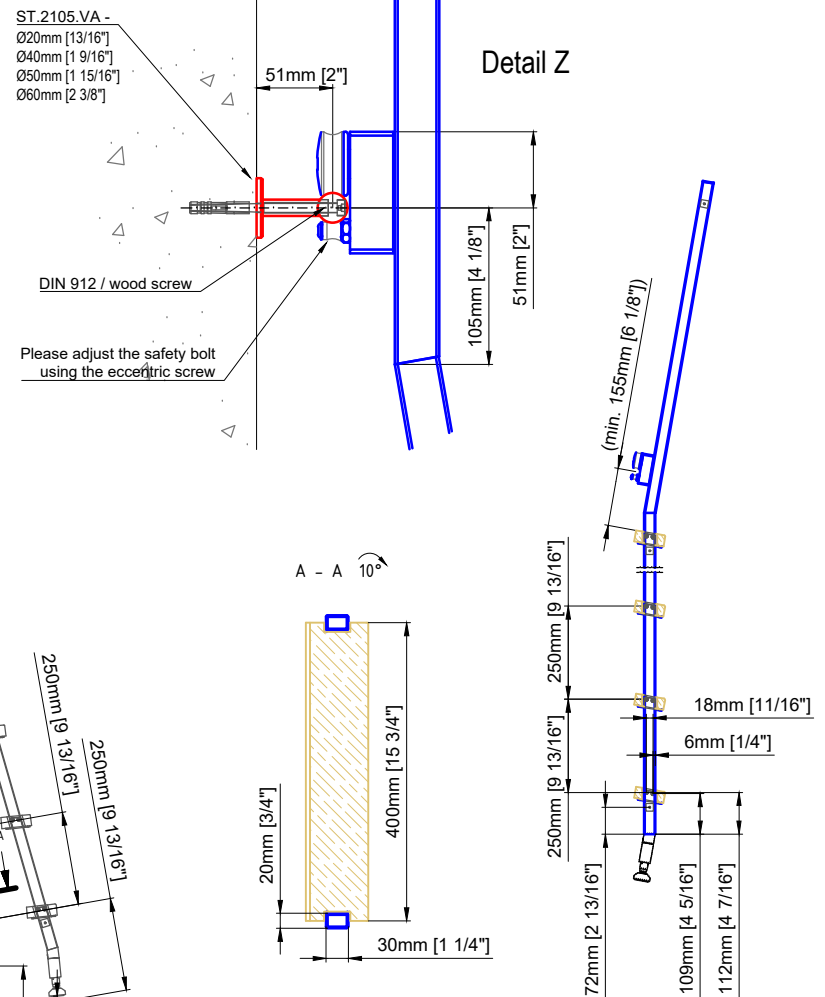
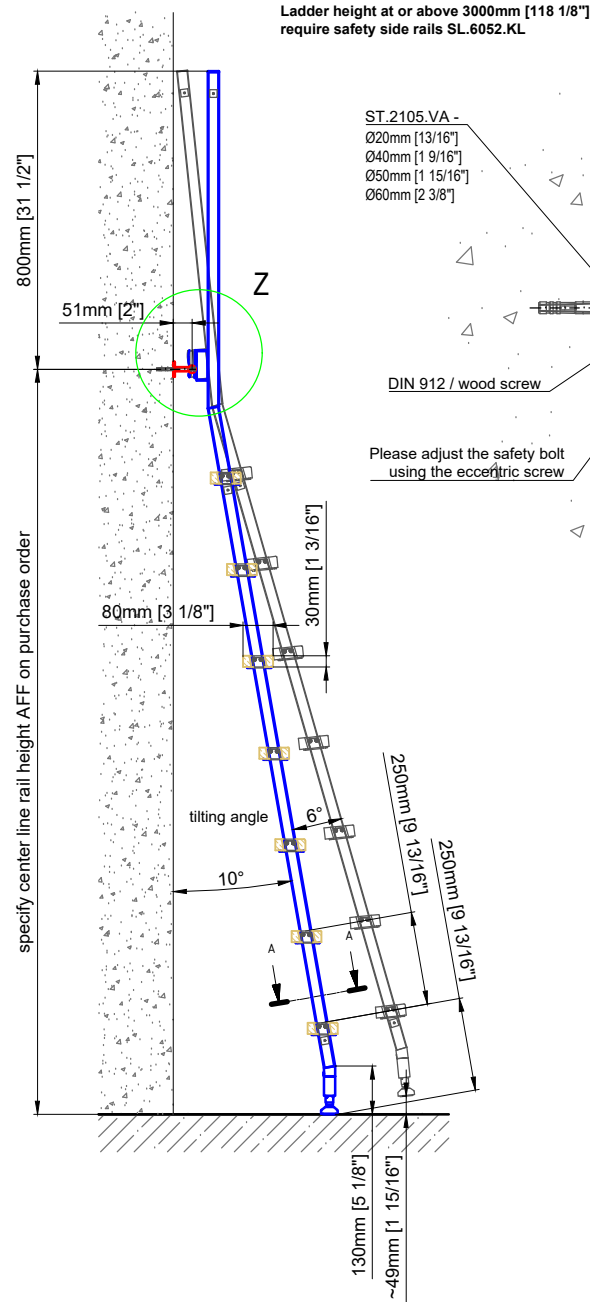
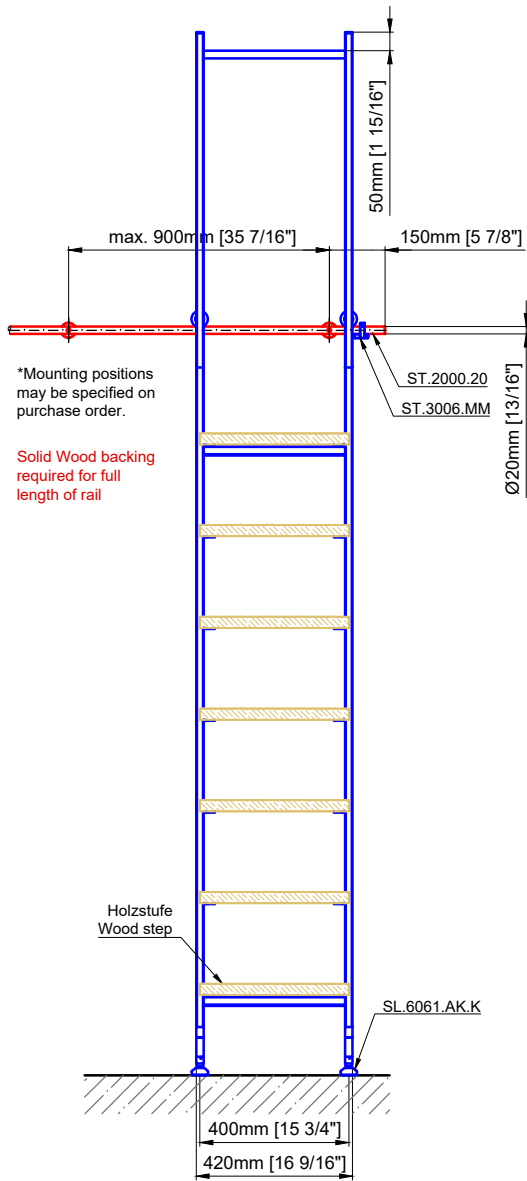

Tangens sliding ladder

SL.6006.AK.H

Date Prepared: May 2024

Prepared By: AB

MWE[®]
 Stainless Steel Manufacturer
 NORTH AMERICA
 Email: sales@mwe-na.com
www.mwe-na.com

Technical drawings are subject to change without notice.
 All millimeter dimensions are exact and supersede inch conversions.

Copyright MWE NA Inc., all rights reserved. Reproduction or other use of these designs without written consent from MWE NA Inc. is prohibited.

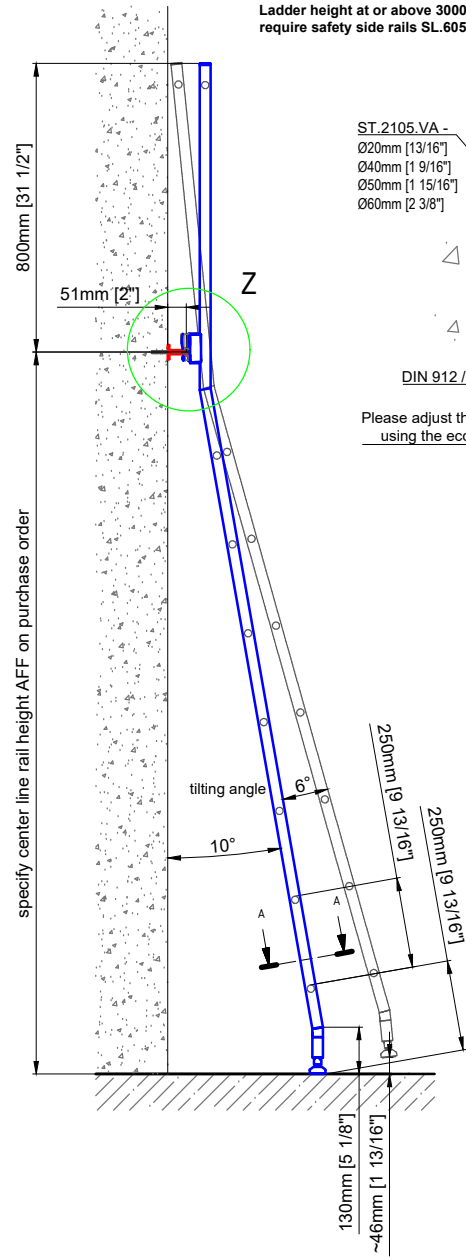
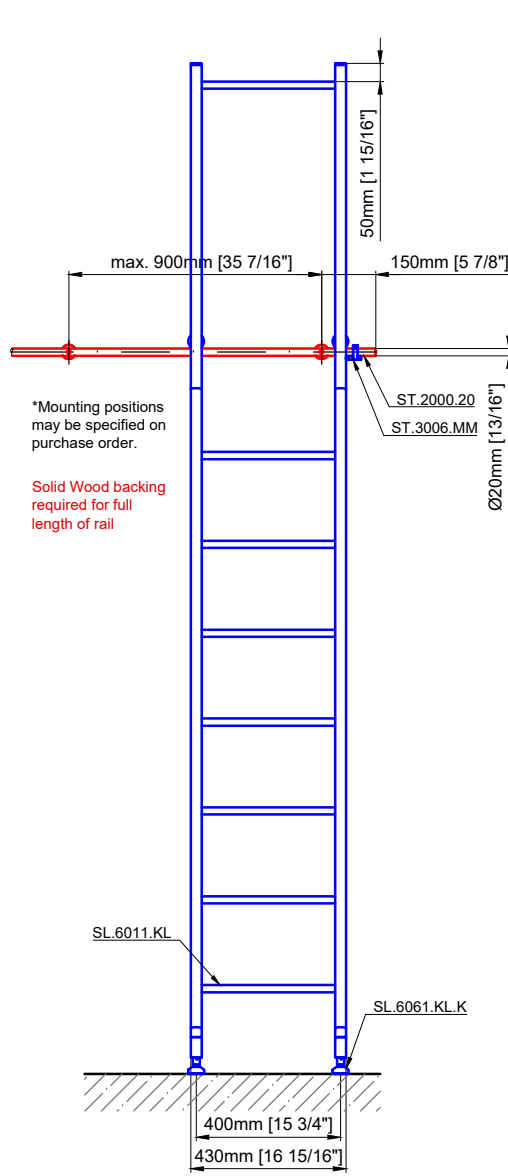

Ladder height at or above 3000mm [118 1/8"] require safety side rails SL.6052.KL

- ST.2105.VA -
- Ø20mm [13/16"]
- Ø40mm [1 9/16"]
- Ø50mm [1 15/16"]
- Ø60mm [2 3/8"]

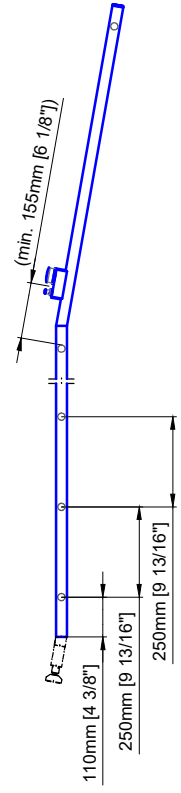
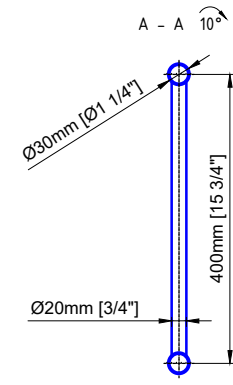
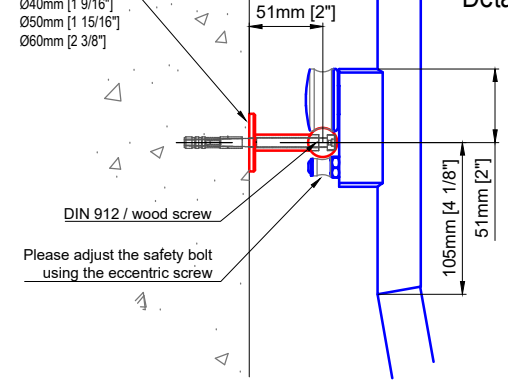

Tangens sliding ladder

SL.6006.KL

Date Prepared: May 2024 | Prepared By: AB

MWE[®]
 Stainless Steel Manufacturer
 NORTH AMERICA
 Email: sales@mwe-na.com
www.mwe-na.com

Technical drawings are subject to change without notice.
 All millimeter dimensions are exact and supersede inch conversions.

Copyright MWE NA Inc., all rights reserved. Reproduction or other use of these designs without written consent from MWE NA Inc. is prohibited.

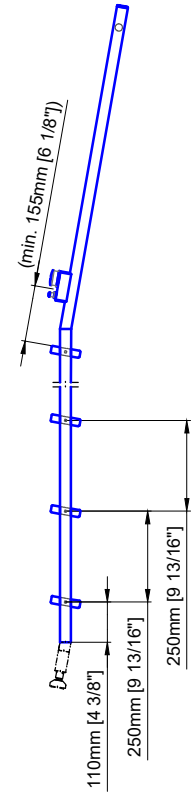
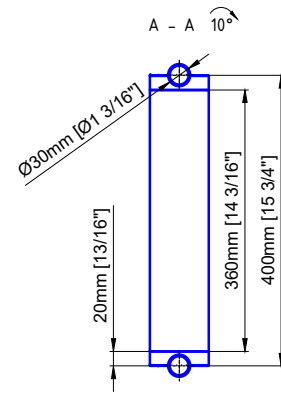
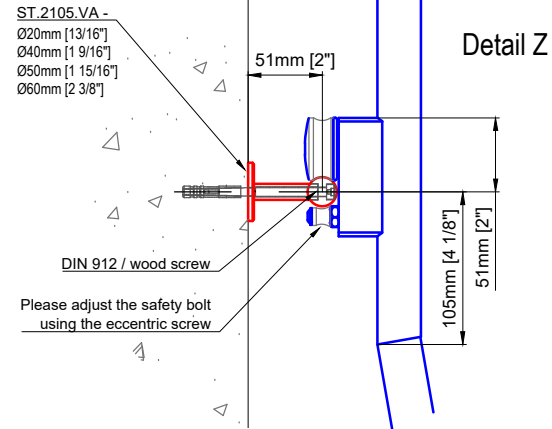
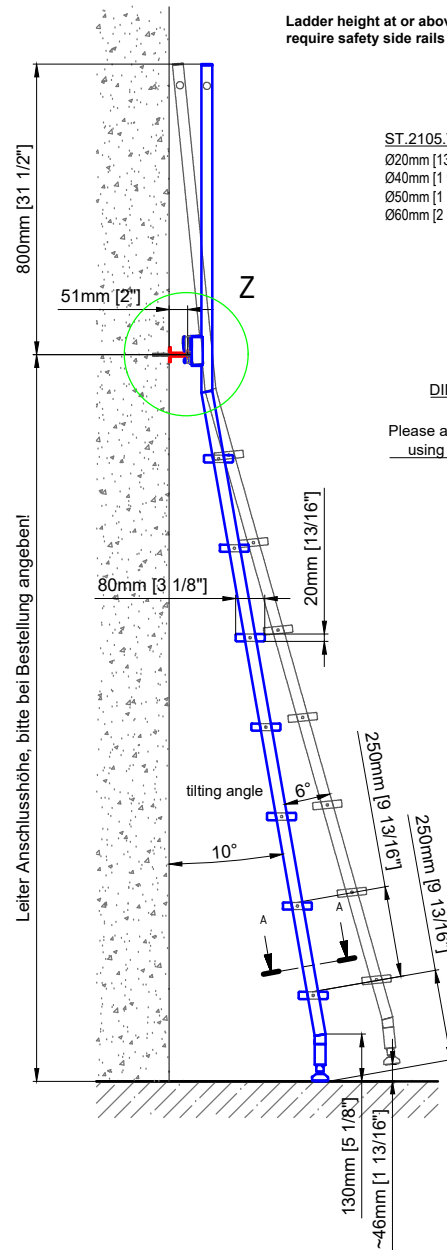
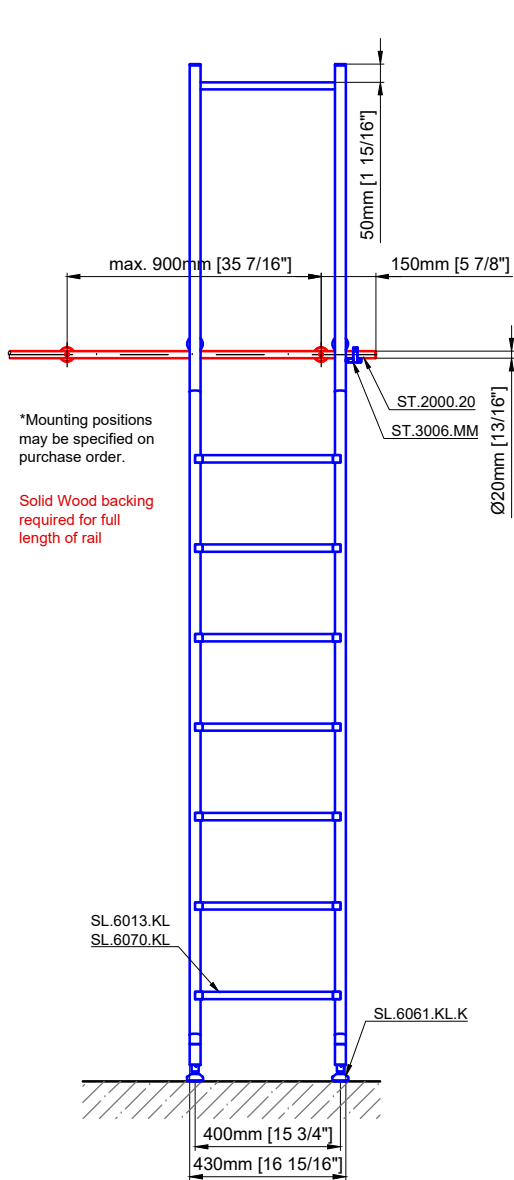

Tangens sliding ladder

SL.6006.KL.E

Date Prepared: May 2024

Prepared By: AB

MWE[®]
 Stainless Steel Manufacturer
 NORTH AMERICA
 Email: sales@mwe-na.com
www.mwe-na.com

Technical drawings are subject to change without notice.
 All millimeter dimensions are exact and supersede inch conversions.

Copyright MWE NA Inc., all rights reserved. Reproduction or other use of these designs without written consent from MWE NA Inc. is prohibited.

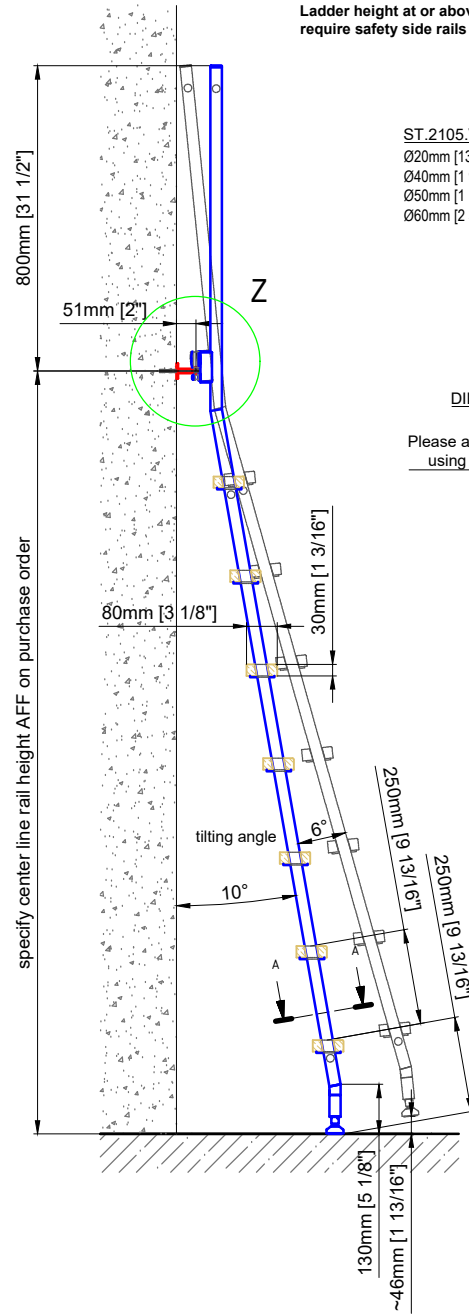
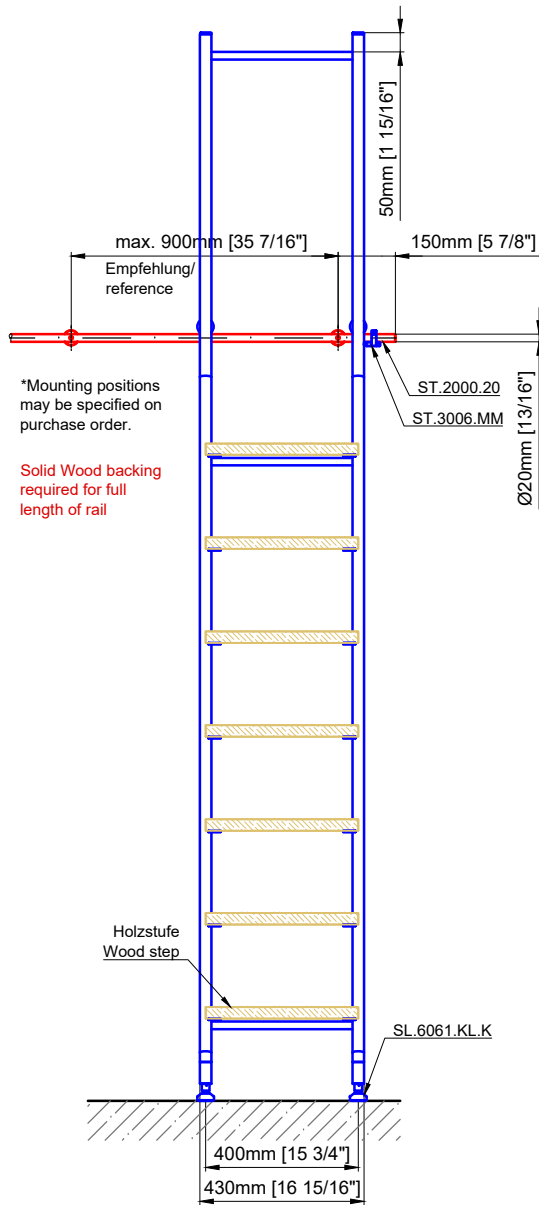

Ladder height at or above 3000mm [118 1/8"]
 require safety side rails SL.6052.KL

ST.2105.VA -
 Ø20mm [13/16"]
 Ø40mm [1 9/16"]
 Ø50mm [1 15/16"]
 Ø60mm [2 3/8"]

51mm [2"]

DIN 912 / wood screw

Please adjust the safety bolt
 using the eccentric screw

Detail Z

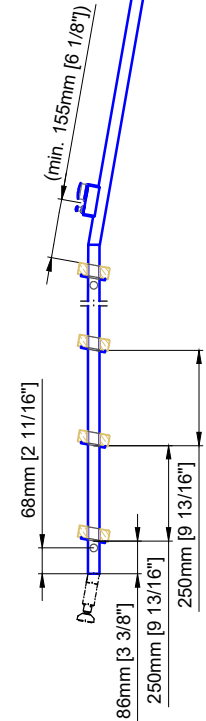
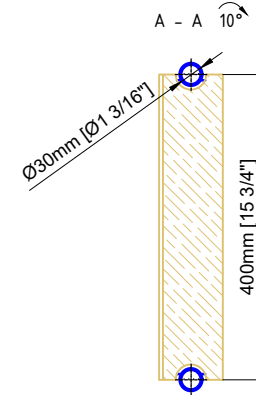

Tangens sliding ladder

SL.6006.KL.H

Date Prepared: May 2024

Prepared By: AB

MWE[®]
 Stainless Steel Manufacturer
 NORTH AMERICA
 Email: sales@mwe-na.com
www.mwe-na.com