

Technical drawings are subject to change without notice.  
All millimeter dimensions are exact and supersede inch conversions.

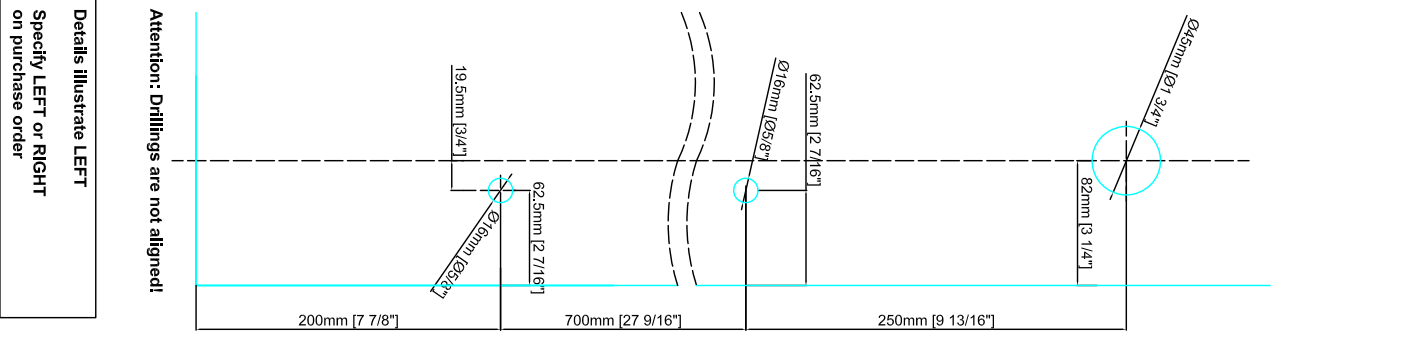

**Attention: Drillings are not aligned!**

**Details illustrate LEFT**  
Specify LEFT or RIGHT  
on purchase order

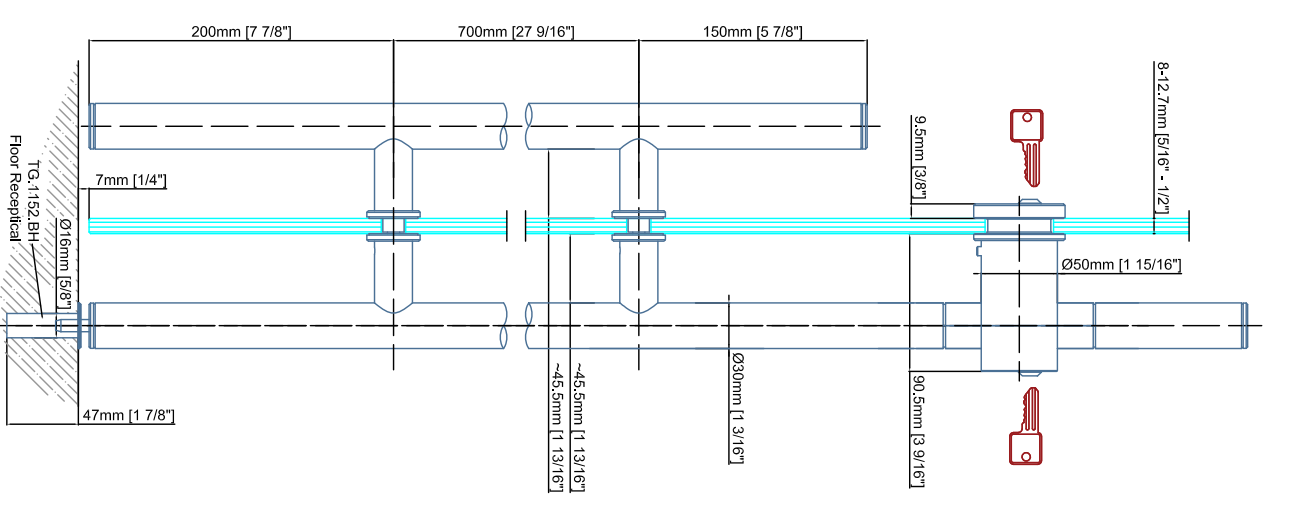
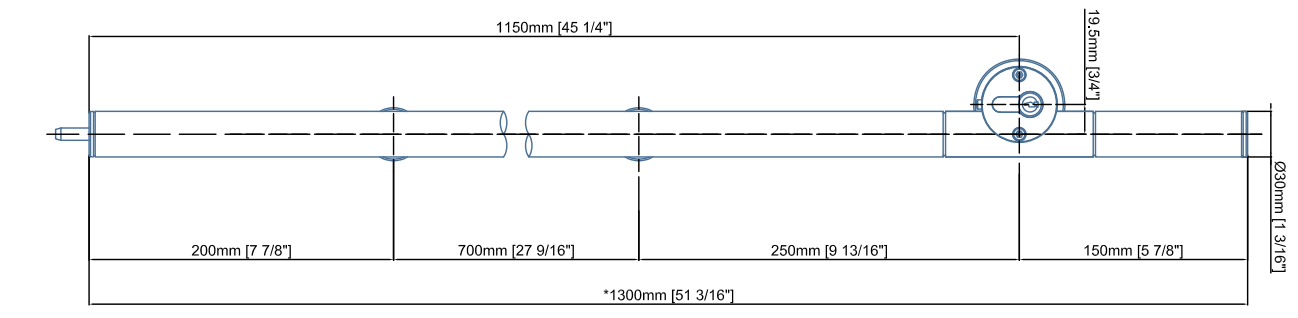

**Stillett** TG-1170,PZJ SECURITY  
Keyed both sides (double cylinder)  
Pull bar handle

Date Prepared: Jan 2019

Prepared By: CDA

Copyright MWE NA Inc., all rights reserved. Reproduction or other use of these designs without written consent from MWE NA Inc. is prohibited.

**MWE**  
NORTH AMERICA  
Email: [info@mwe-na.com](mailto:info@mwe-na.com)  
phone: (954) 982-6595  
[www.mwe-na.com](http://www.mwe-na.com)

Technical drawings are subject to change without notice.  
All millimeter dimensions are exact and supersede inch conversions.

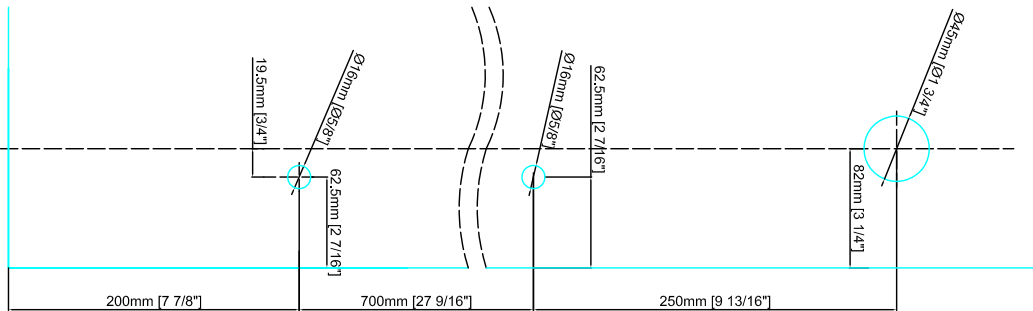
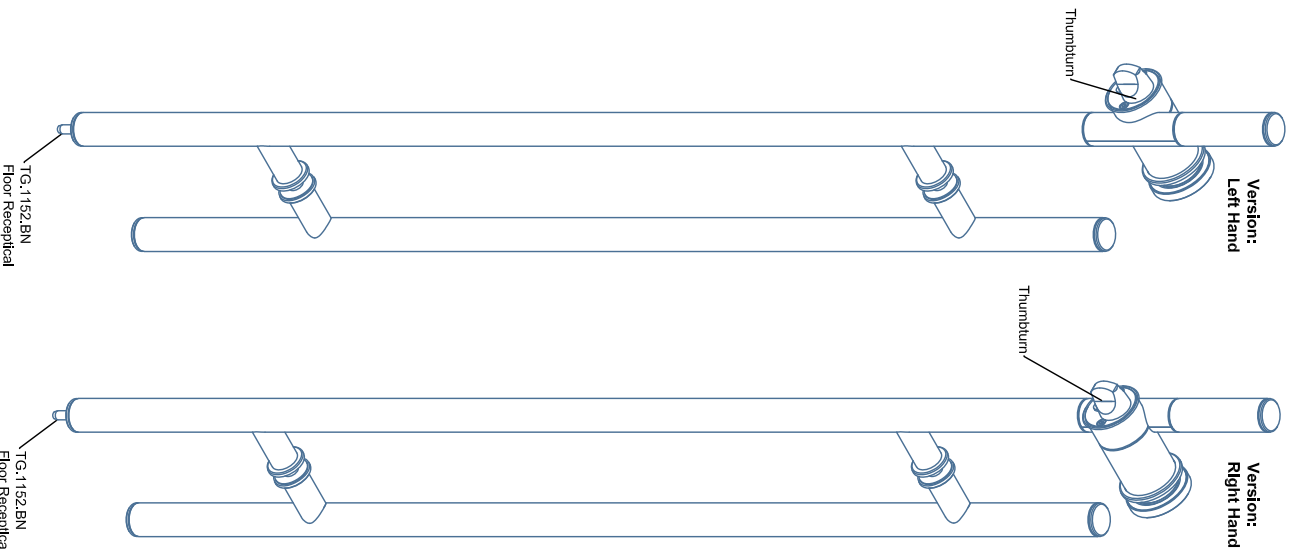

Attention: Drillings are not aligned!

Details illustrate LEFT  
Specify LEFT or RIGHT  
on purchase order

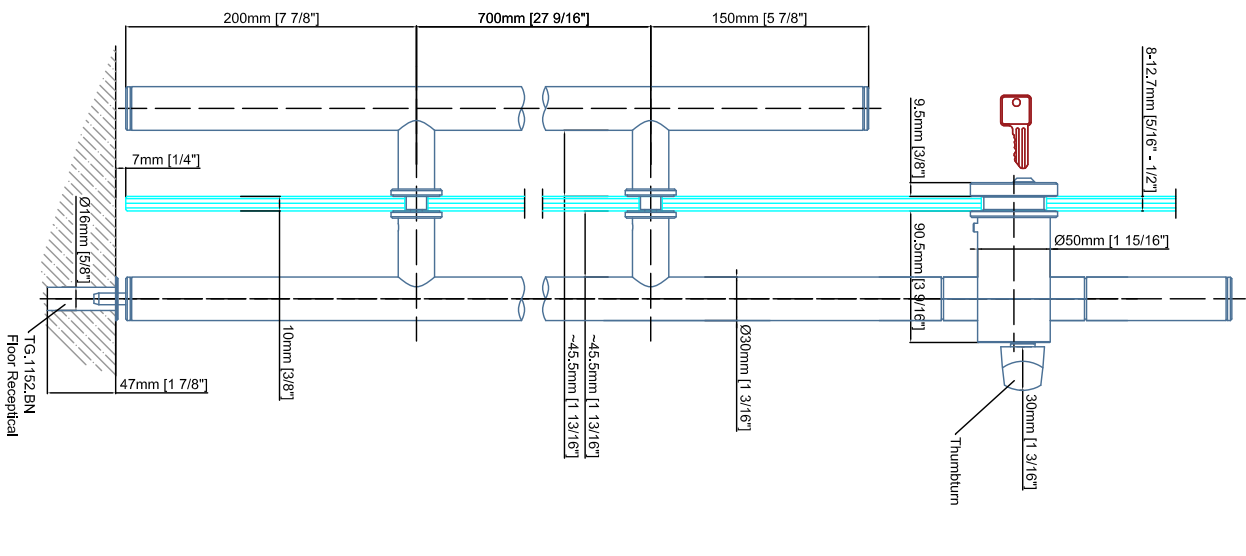
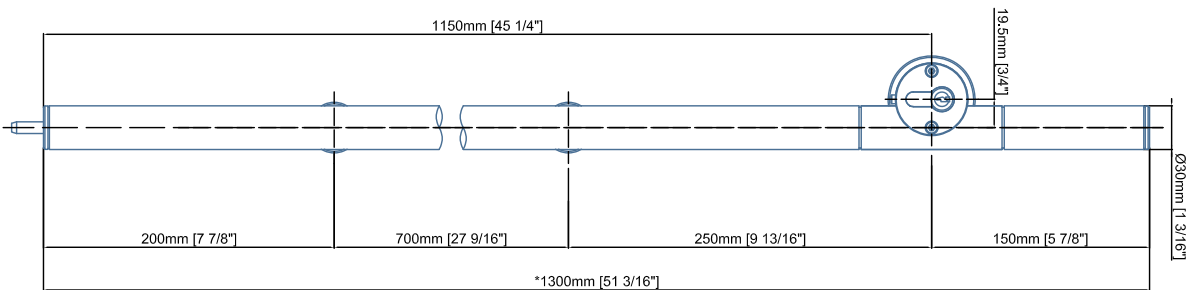

Stillett [TG:1170,PZ,WG]  
Date Prepared: Jan 2019

Prepared By: CDA

Keyed one side thumbturn opposite (single cylinder)  
Pull bar handle

Copyright MWE NA Inc., all rights reserved. Reproduction or other use of these designs without written consent from MWE NA Inc. is prohibited.