

Technical drawings are subject to change without notice.
All millimeter dimensions are exact and supersede inch conversions.

Copyright MWE NA Inc., all rights reserved. Reproduction or other use of these designs
without written consent from MWE NA Inc. is prohibited.

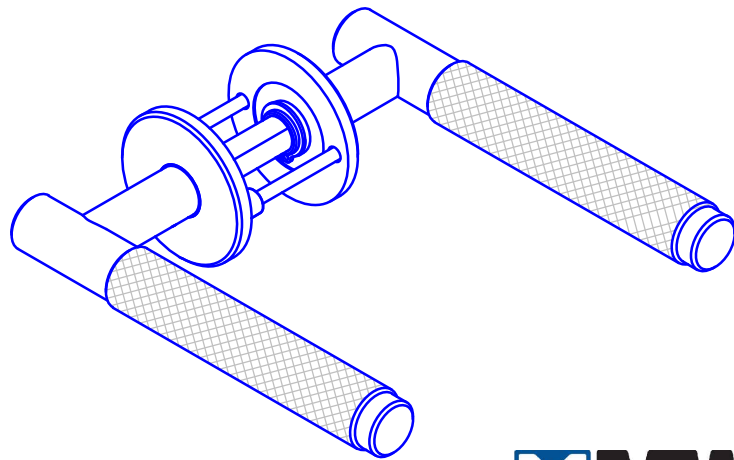
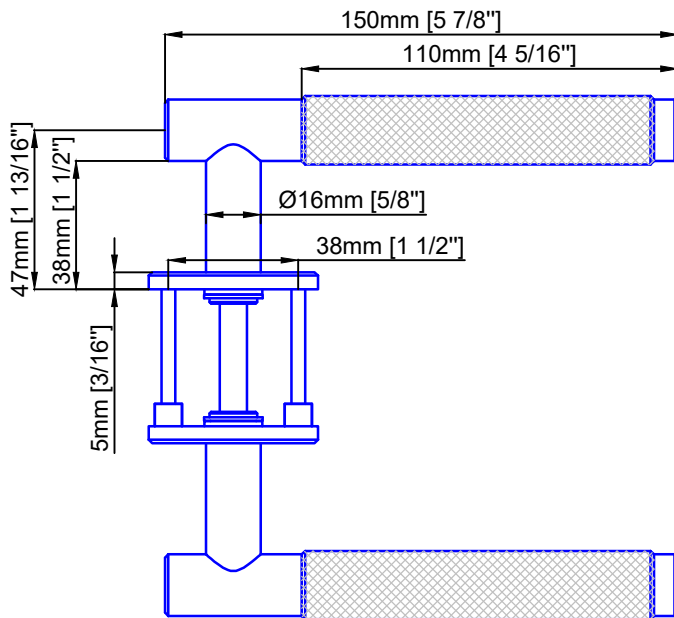
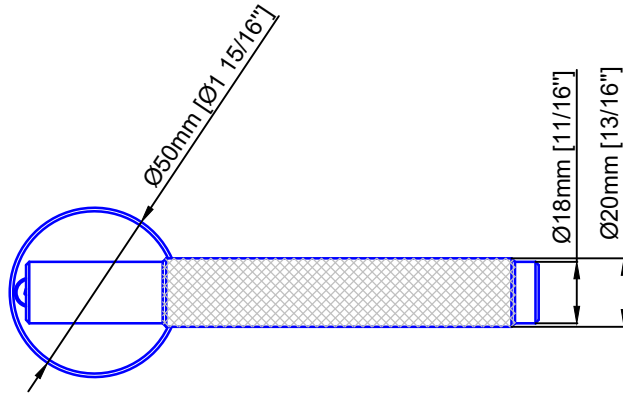

Door Lever Aspero

TD.1413.AP

Date Prepared: November 2023

Prepared By: AB



Stainless Steel Manufacturer
NORTH AMERICA

Email: sales@mwe-na.com
www.mwe-na.com